



ROTAX®



Potential of Different Injection Systems for High Performance Two-Stroke Engines

Nigel FOXHALL / Walter HINTERBERGER
Franz WINKLER / Roland OSWALD / Oliver SCHÖGL

*BRP-Powertrain GmbH & Co KG,
IVT - Technische Universität Graz*

Content

- Motivation
- System Descriptions
- Selected results
- Summary & Conclusions



Motivation : 2 stroke Powersports

2 Stroke Benefits

- Excellent power to weight ratio
 - 800 cc BRP 2-stroke engine: 200 PS/Liter;
 - 1000 cc BRP 4-stroke NA engine: 100 PS/Liter
- Small package
- Reverse engine rotation
- Low Maintenance
- Low System costs

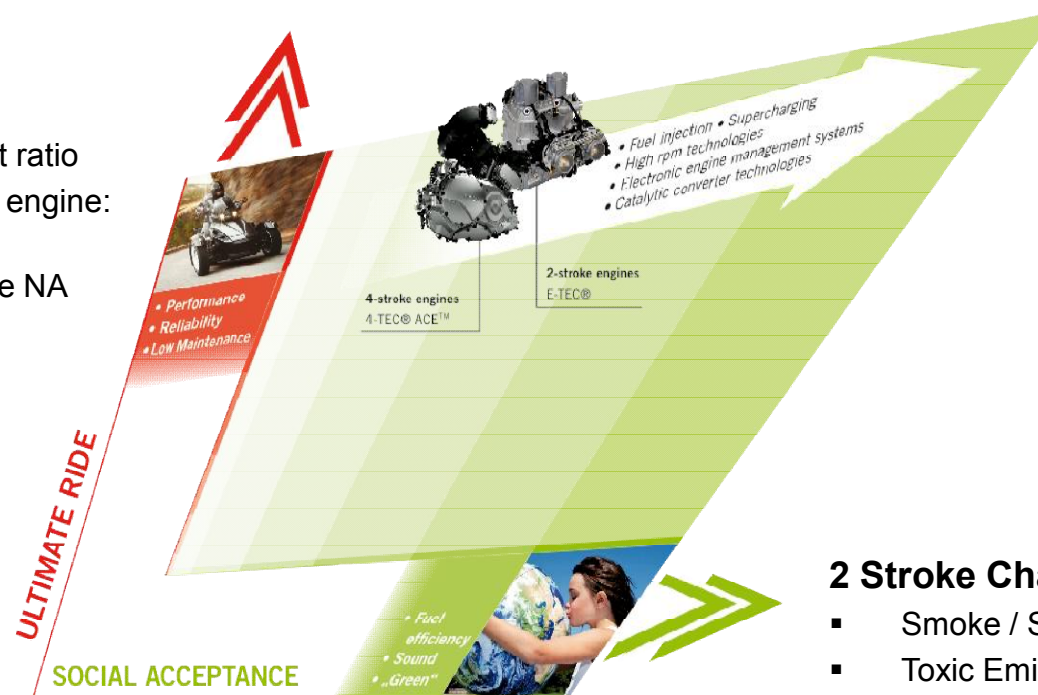

2 Stroke Challenges

- Smoke / Smell
- Toxic Emissions
- Fuel consumption
- NVH

Motivation : 2 stroke Powersports

- Excellent power to weight ratio
 - 800 cc BRP 2-stroke engine:



Defining the correct injection technology for the vehicle application is key for 2 stroke success



- Toxic Emissions
 - High HC during scavenging
- High Fuel consumption
- NVH

Content

- Motivation
- System Descriptions
- Selected results
- Summary & Conclusions



System Descriptions

- 3 different injection systems were used for the comparison
 - E-TEC (existing on 593 engine)
 - SDI (previously existing on 593 engine)
 - LPDI (adapted to ETEC cylinder)
- Base engine for all tests Rotax 593
 - 594cm³ two-stroke In Line two-cylinder
 - Rated power 78 kW @ 8200 1/min
 - Bore 72 mm / Stroke 73 mm
 - Reed valve and throttle body on each crankcase
 - Lubrication by electric oil pump direct into the crankcase
 - Electronic controlled exhaust slider
 - Currently in production in Skidoo snowmobiles



System Descriptions - ETEC

- High pressure direct injection 25-40 bar
- Injector location in centre of cylinder head
- Injection direct onto spark plug
- Pre pressure pump 2,5 bar
- Voltage supply for DI injector is 55 V
- Batteryless start to -30°C
- In production Evinrude Outboard since 2003
- In production in Skidoo since 2009
- Over 500,000 ETEC engines produced to date

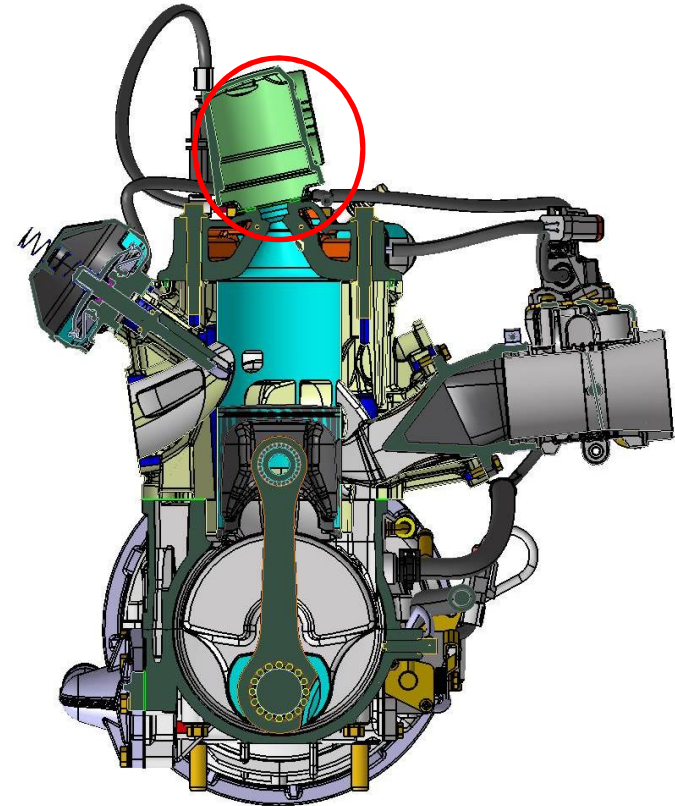

System Descriptions – ETEC stratified mode



System Descriptions - SDI

- Low pressure injection 4 bar
- Injector location in the side transfer ports
- 2 standard PFI Injectors per cylinder
- In part load, injection alternates between the two injectors
- In production on Skidoo 2003 – 2010

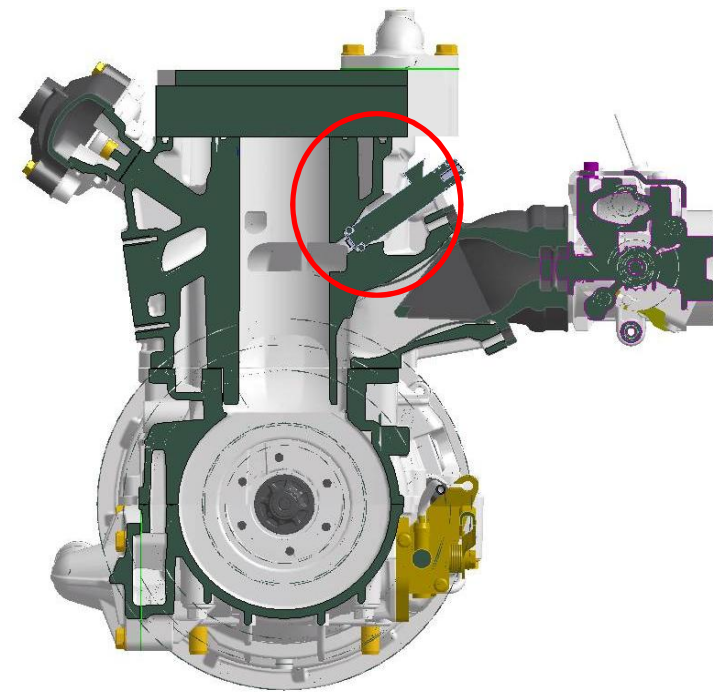

System Descriptions - SDi



System Descriptions - LPDI

- Low pressure direct injection 5 bar
- Injector location in cylinder wall, downwards towards cylinder center
- 2 standard PFI injectors per cylinder
- In part load, injection alternates between the two injectors
- Modified E-TEC cylinder used for injection holes
- Cylinder head from SDI

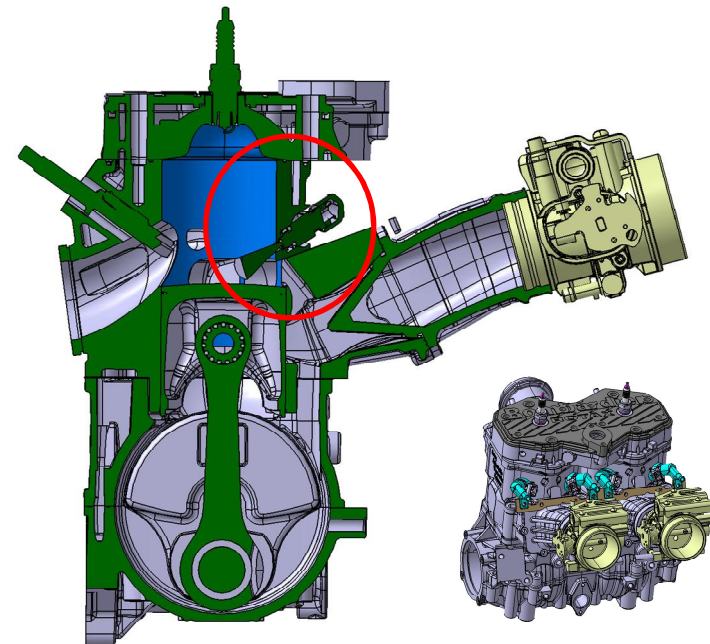

System Descriptions - LPDI

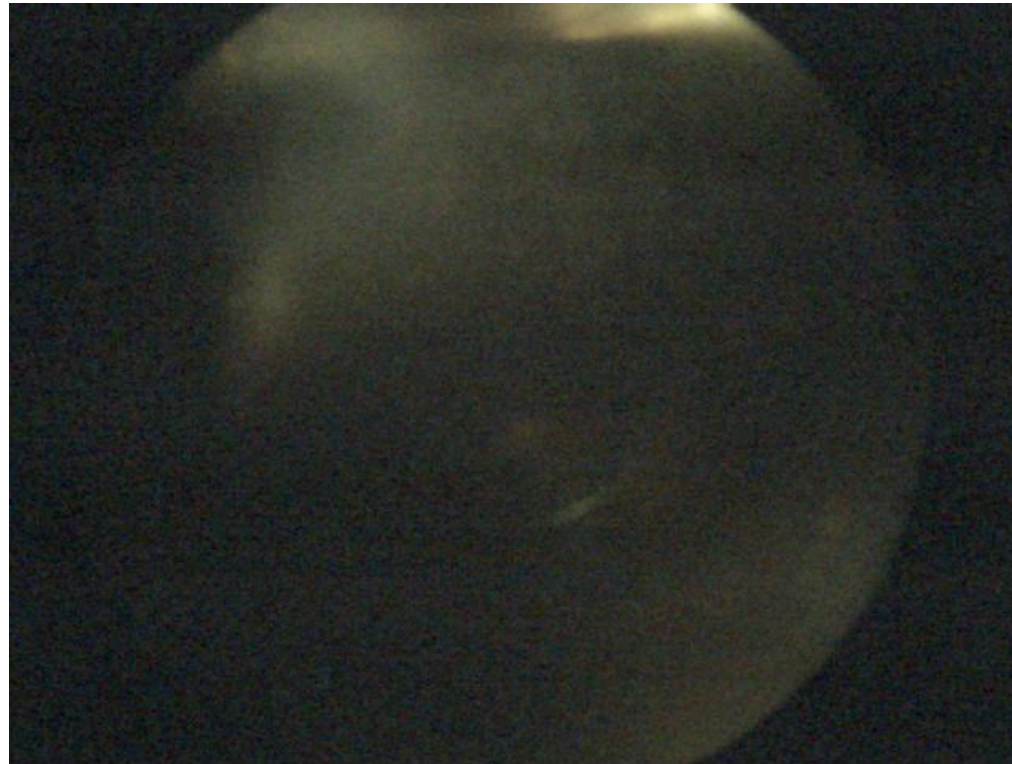

90.0 deg CA

Content

- Motivation
- System Descriptions
- Selected results
- Summary & Conclusions



Selected Results Summary

- Low load conditions are ideal for E-TEC technology due to late injection timing.
- At higher load the LPDI system can achieve similar or better values than E-TEC.
- SDI system is worse than the other systems due to the geometrical limitation of the injection window plus not ideal mixture preparation
- Plotting the HC emissions over the useful operating range of the engine provides an overview of the system benefits.

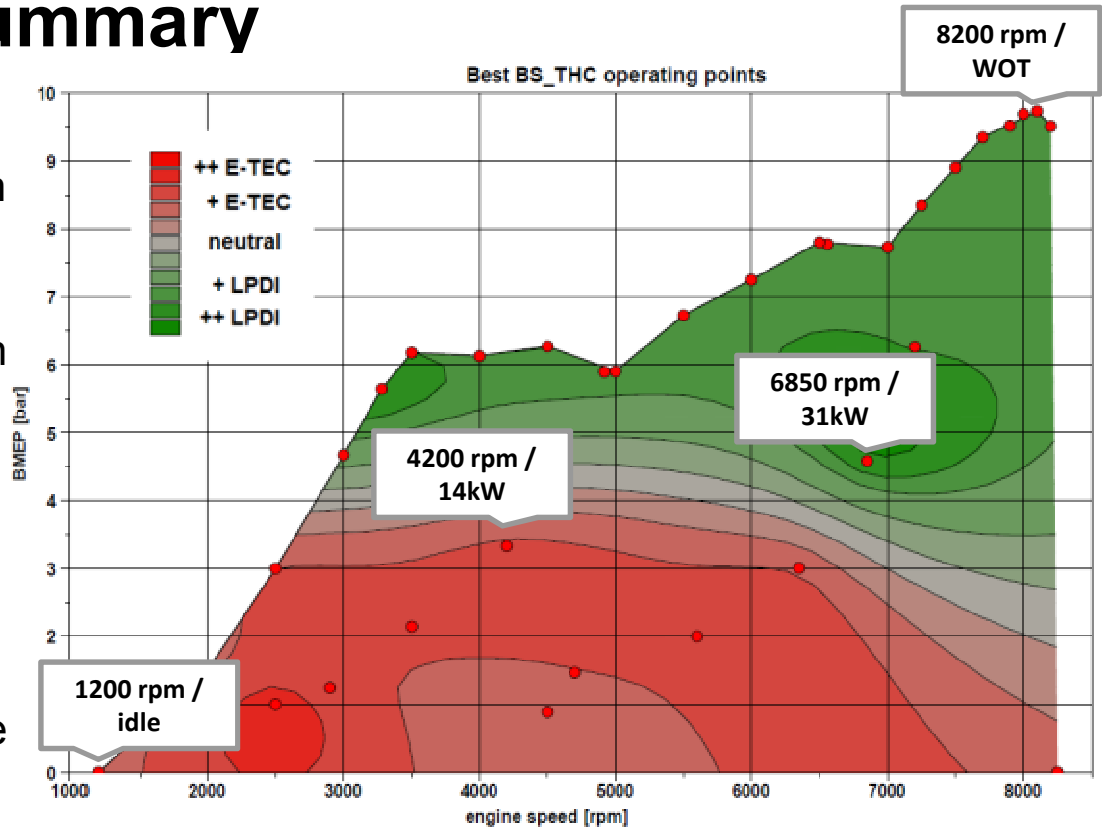

Selected Results : 1200 rpm / idle

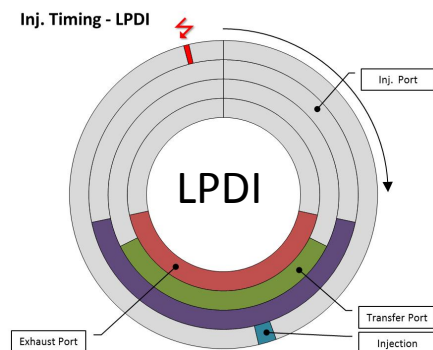
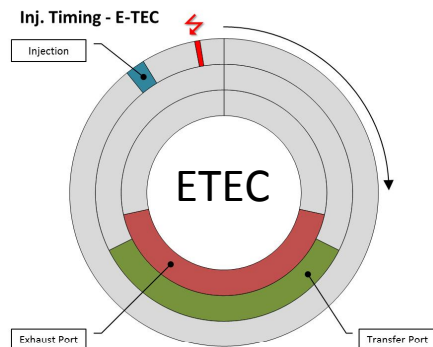

- Due to the possibility to inject very late with ETEC, there is effectively zero loss of unburned fuel during scavenging
- Late injection also allows a compact air / fuel pocket allowing stratified combustion
- The fuel spray can be seen to impinge on the piston crown, causing not ideal combustion due to classic “wall wetting”
- Since injection can only occur when both the transfer ports and the exhaust port is open; there is a back flow of fuel into the crankcase which is then partly lost in the next scavenge cycle.
- A rich mixture is seen at the squish area on the intake side indicating combustion chamber not optimised for LPDI

E-TEC

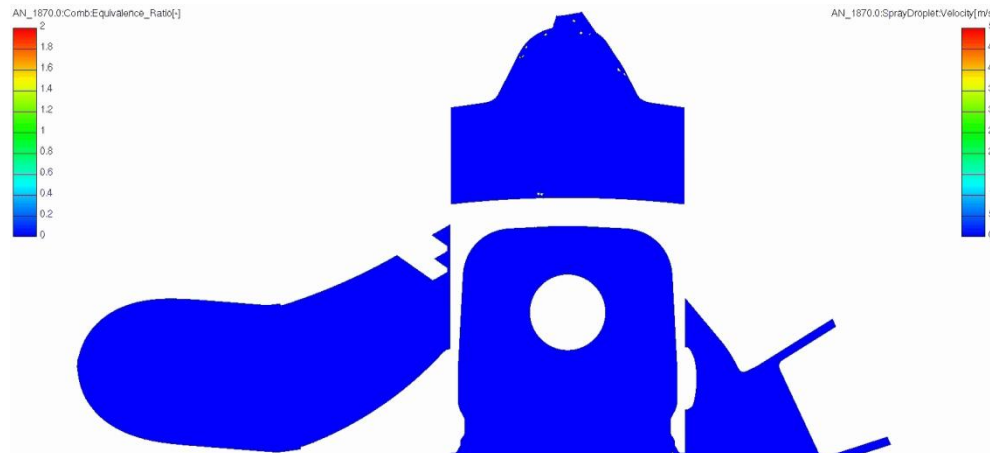

1200 rpm / Idle

LPDI

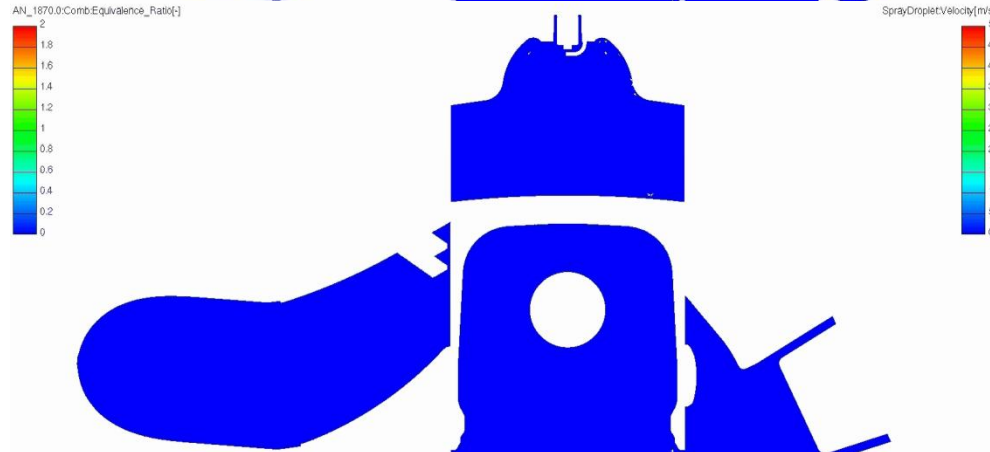

Equivalence Ratio

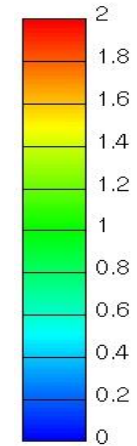

Selected Results : 4200 rpm / 14kW

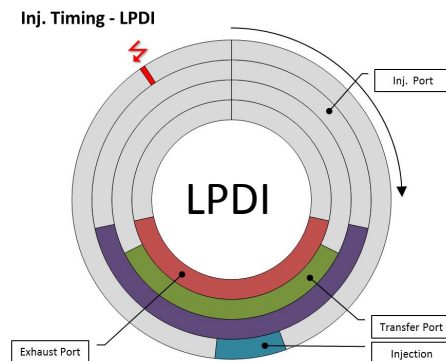
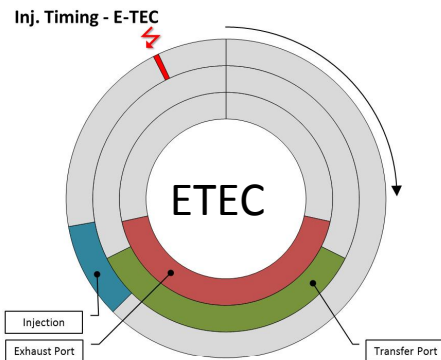

- Since injection begins shortly before the exhaust port closes there is no visible loss of unburned fuel during scavenging
- A later injection would be possible but at this timing unburned fuel loss during scavenging is minimised whilst residence time (mixture preparation) is maximised.
- Homogeneous mixture can be seen at ignition
- Injection timing is similar to idle and it can again be seen that some fuel is lost into the crankcase at the beginning of injection.
- Some of this fuel will be lost during the early part of the next scavenge cycle
- Additionally some unburned fuel is also lost direct into the exhaust at the very end of the scavenge process

E-TEC

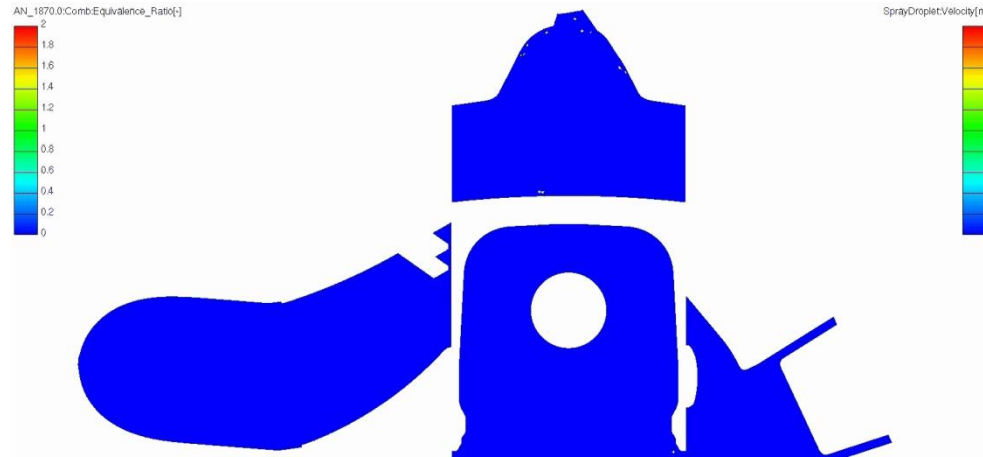

4200 rpm / 14 kW

LPDI

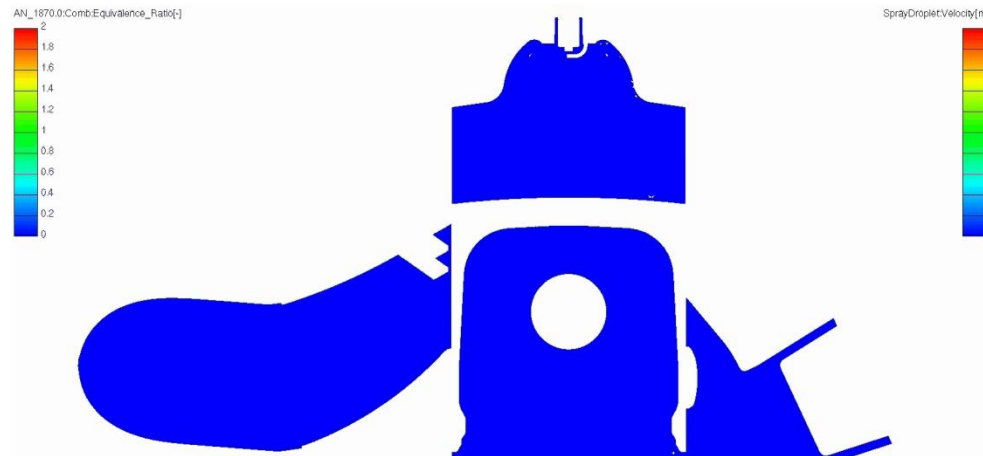

Equivalence Ratio

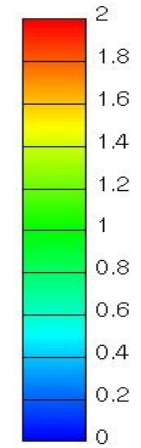

Selected Results : 6850 rpm / 31kW

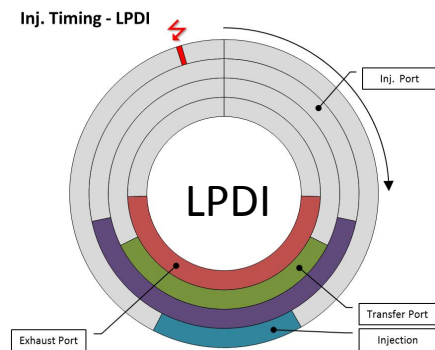
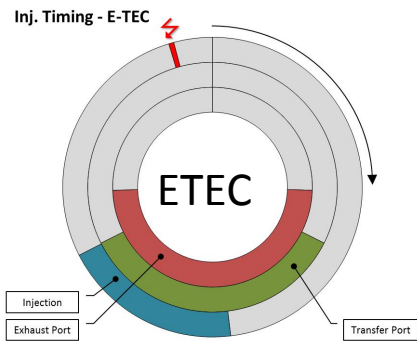

- End of injection is at a similar point to that at the 4200 rpm point; however due to longer injection duration Start of Injection is at approx BDC when exhaust port fully open
 - This leads to loss of unburned fuel at the end of the scavenging phase
 - Later injection did not give optimum result likely due to reduced residence time
-
- Although start of injection is similar to ETEC, the longer path from injector to exhaust port means no visible loss of unburned fuel during scavenging
 - High gas velocity from the transfer ports prevents fuel going direct out of the exhaust port

E-TEC

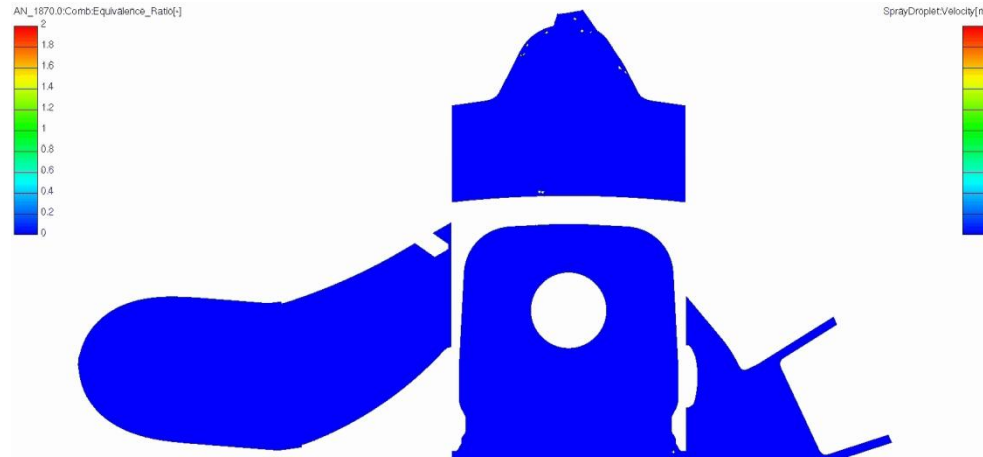

6850 rpm / 31 kW

LPDI

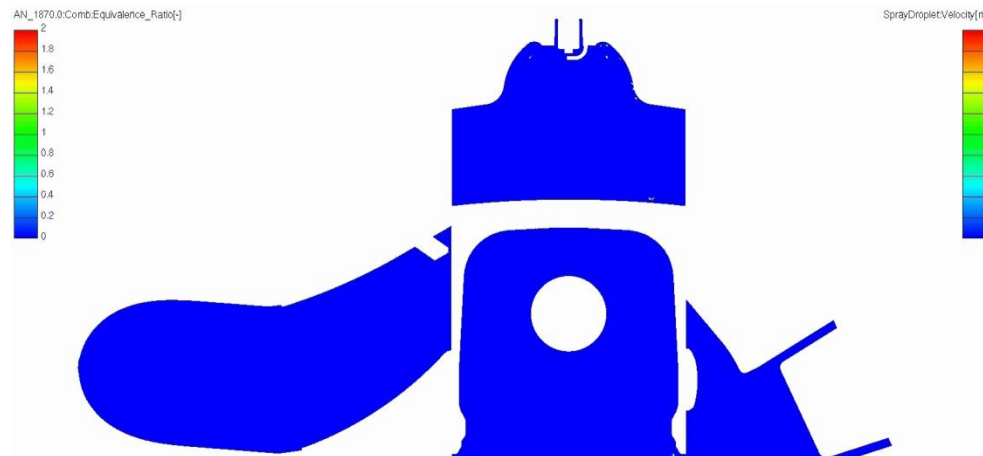

Equivalence Ratio

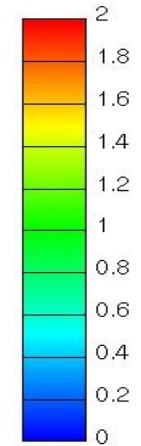

Selected Results : 8200 rpm / WOT

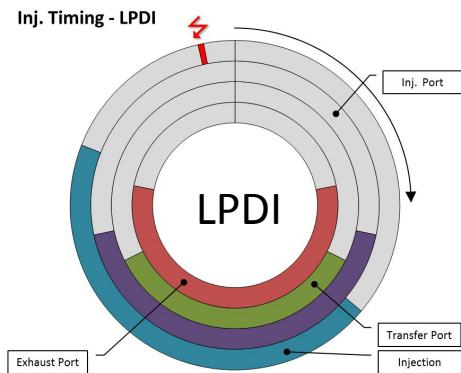
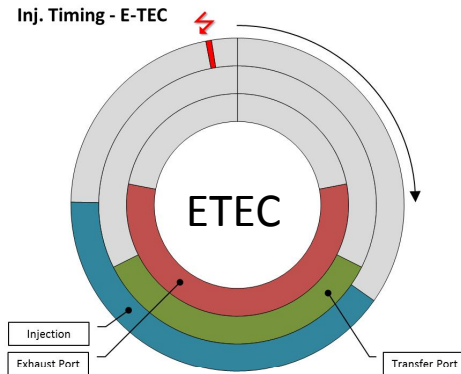

- Injection duration is during exhaust open period
- Although some fuel lost during scavenging is returned from the exhaust pressure wave, a significant amount of unburned fuel is lost during the scavenging process
- Mixture at point of ignition not ideal
- Due to the injectors flow being too small, injection continues after the piston passes, the fuel remaining in the bore is then lost to the exhaust at the beginning of the next cycle
- Generally all fuel injected before piston passes injector is contained in the cylinder and not lost during scavenging
- A reduced richness or slightly higher flow injectors would improve this result further

E-TEC

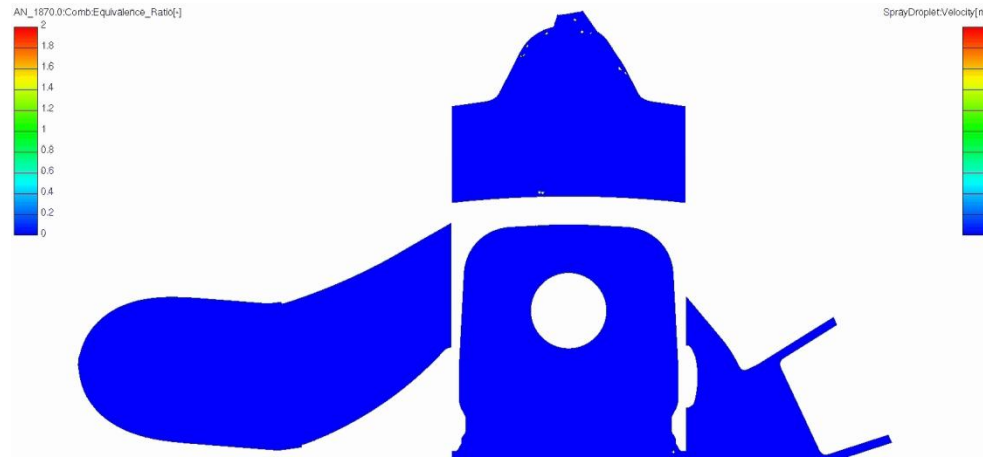

8200 rpm / WOT

LPDI

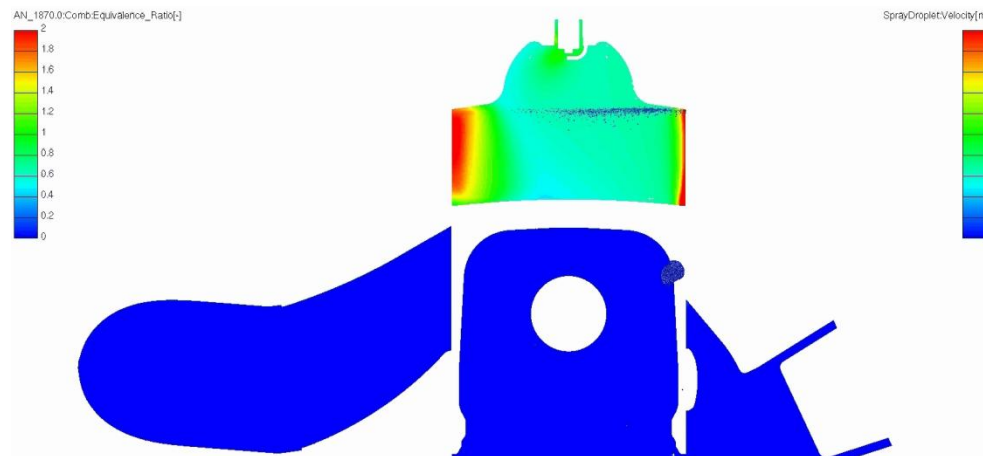

Equivalence Ratio

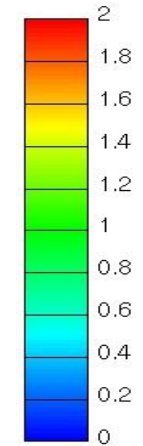

Content

- Motivation
- System Descriptions
- Selected results
- Summary & Conclusions

Summary & Conclusions

- The injection system is a trade off between
 - Later injection minimising loss of fuel during exhaust port opening time
 - Earlier injection to ensure good mixture preparation at spark plug
- E-TEC and LPDI system are appropriate technologies for different applications.
- At Low and Medium Loads :
 - Direct Injection in the cylinderhead (HPDI) allows injection timing after the exhaust port has closed in the low and medium load range
 - This leads to significantly reduced unburned fuel loss during scavenging whilst maintaining sufficient residence time for good mixture preparation
- At Higher loads (and therefore higher injection rates) :
 - Direct Injection in the cylinder above the transfer ports (LPDI) allows excellent fuel preparation and little loss of unburned fuel during scavenging due to the longer transfer path.
 - HPDI, due to being further downstream in the scavenge flow, loses unburned fuel into the exhaust
- A combined system could be considered an excellent choice for low HC and high BMEP engines
- Higher injection pressure in the HPDI could extend the load range where HPDI benefits LPDI; however End Of Injection cannot be too late or else good mixture preparation is sacrificed

Ski-Doo®
Lynx®
Sea-Doo®
Evinrude®
Rotax®
Can-Am®



THE ULTIMATE POWERSPORTS EXPERIENCE



© 2014 BRP. All rights reserved. / ™ ® and the BRP logo are trademarks of BRP or its affiliates.